

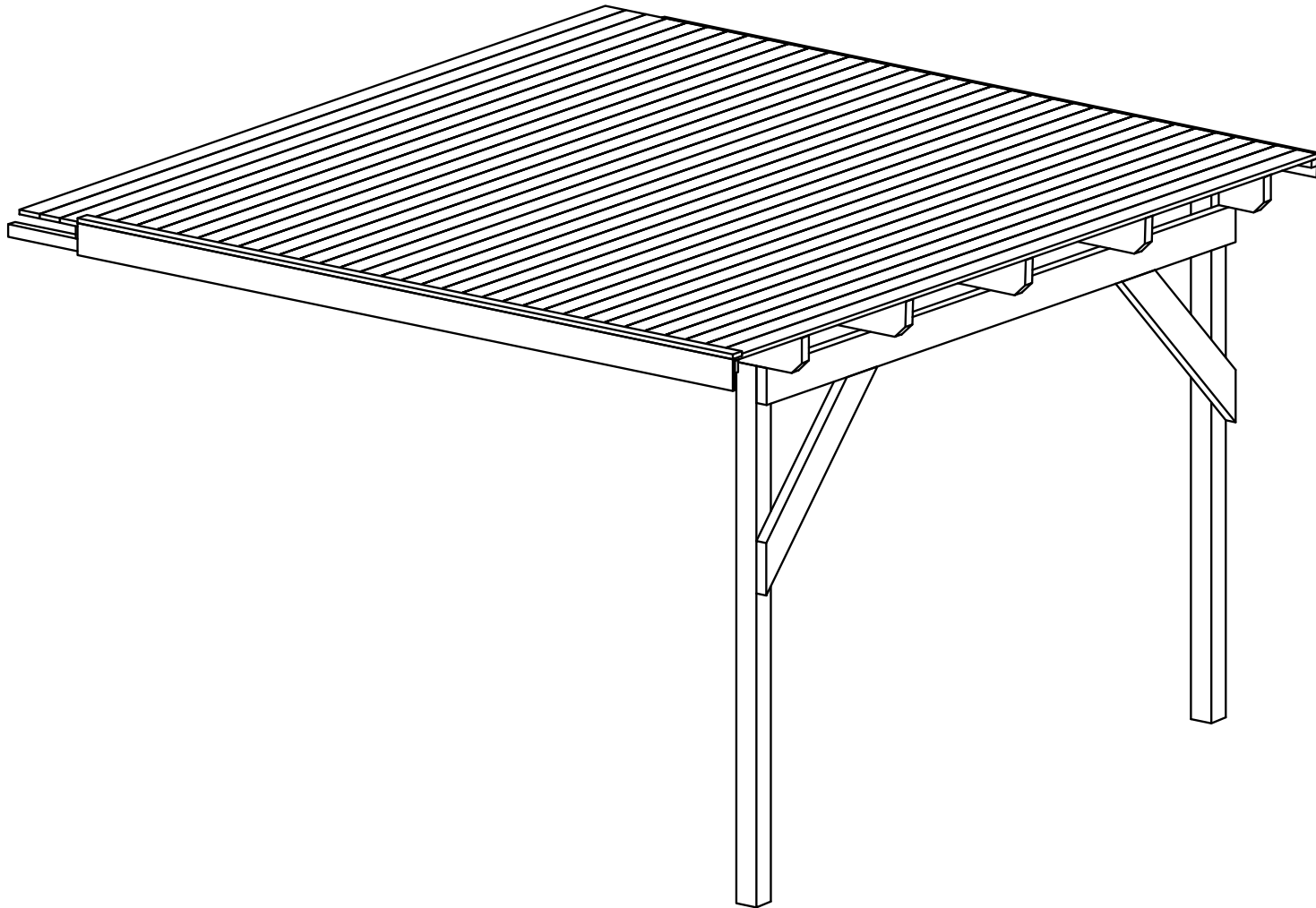









Anbau für Schönheim 1&2

Art. Nr. 992400

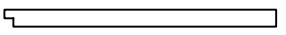
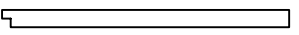
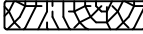
1/7

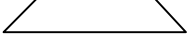
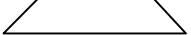

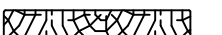
29.08.2017

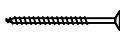
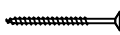
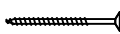
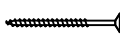
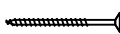
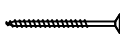
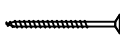
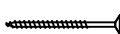
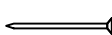
Pos	Piece list - Stückliste - Liste des pièces - Elementi - Stuklijst - Tükitalabel 29.08.2017 Art. Nr. 992400 2/6	Q	P (mm)	L (mm)
DB	Roof boards - Dachbretter - Voliges - Perlina per tetto - Dakhout - Katuselaud 	35	18x90	3650
DPL3	Roofing felt fillet - Dachpappenleiste - Baguette de fixation du feutre bitumeux - Asse per fissaggio guaina bituminosa - Afdeklijst asfaltpapier - Katusepapiilist 	1	18x58	2900
RS3	Roof support - Dach träger - Support de toit - Supporto del tetto - Dak ondersteuning - Katusetugi 	1	44x44	600
RS2	Roof support - Dach träger - Support de toit - Supporto del tetto - Dak ondersteuning - Katusetugi 	1	44x44	2900
P2	Post - Pfosten - Poteau - Piede registrabile - Stijl - Post 	1	90x90	2000
P1	Post - Pfosten - Poteau - Piede registrabile - Stijl - Post 	1	90x90	2100
TB2	Fascia board - Traufbrett - Bandeau de toit - Finitura lati tetto - Gevellijst - Räästalaud 	1	18x90	2900
DRV2	Roof edge reinforcement - Dachrandverstärkung - Corniere de renfort de bord de toit - Rinforzo x tetto - Dakrand versterking - Räästatugevdus 	1	28x34	2900
PR4	Beam - Balkenlage - Solive(s) - Trave - Balk (gording) - Tala 	1	44x140	979
PR3	Beam - Balkenlage - Solive(s) - Trave - Balk (gording) - Tala 	1	44x140	998
PR2	Beam - Balkenlage - Solive(s) - Trave - Balk (gording) - Tala 	1	44x140	2928
PR1	Beam - Balkenlage - Solive(s) - Trave - Balk (gording) - Tala 	5	44x140	3100
GL3	Gable moulding - Giebelleiste - Planche de rive - Finitura per frontale e retro del tetto - Gevellijst - Viilulaud 	1	18x120	2900
HS9	Screw for gable moulding - Schrauben für giebelleiste - Vis pour fixation planche de rive - Vite per fissare finiture davanti e dietro del tetto - Schroef voor gevellijst - Kruvi viilulauale 	10	3.5x50	
HS14	Screw for fixing roof support - Schraube zur befestigung dach träger - Vis de fixation support de toit - Vite per il fissaggio del supporto del tetto - Schroef voor bevestiging dakdrager - Kruvi katusetoele 	4	4.5x80	
HS14	Screw for post - Schrauben für pfosten - Vis de fixation des poteaux - Viti per inviare - Schroef voor stijlen - Kruvi postile 	4	4.5x80	
HS12	Screw for metal corner - Holzschraube für metallwinkel - Vis de fixation des cornieres en métal - Viti per fissare suadretta di metallo di giunzione - Schroef voor metalen hoek - Kruvi nurgikule 	36	4x40	
HS12	Screw for fascia boards - Schrauben für traufbretter - Vis pour fixation bandeau de toit - Viti x striscia del tetto - Schroef voor gevellijst - Kruvi räästalauale 	7	4x40	
HS12	Screw for roof edge reinforcement - Schrauben für dachrandverstärkung - Vis pour fixation corniere renfort de bord de toit - Viti x rinforzo bordo tetto - Schroef voor dakrand versterking - Kruvi räästatugevdusele 	25	4x40	
HS22	Screw for beam - Schrauben zur befestigung dachsparren - Vis pour solive - Viti per perline - Schroef voor balk (gording) - Kruvi talale 	2	6x150	
HS20	Screw for post height adjustment - Schrauben für regulierungsschraube für pfosten - Vis de fixation de support réglable de poteau - Viti per fissare ed aggiustare l'altezza del palo verticale - Schroef voor hoogte instelling sfijlen - Kruvi vajumispoldile 	16	6x50	
HS21	Screw for beam - Schrauben zur befestigung dachsparren - Vis pour solive - Viti per perline - Schroef voor balk (gording) - Kruvi talale 	32	6x80	
NF4	Zn nail for roof - Zn nagel für dachbretter - Pointe pour fixation voliges de toit - Chiodi x perline tetto - Spijker(nagel) voor dakhout - Nael katuselauale 	180	2x50	

Art.Nr. 992400

Groundplan - Grundplan - Plan de masse -
Planimetria - Plattegrond - Põhiplaan

